

Frontier Lab's proprietary MicroJet system achieves a cryo-trapping temperature of  $-196^{\circ}\text{C}$  at the head of a GC separation column

*Compatible with a variety of sample introduction devices*

**New!**

# Universal Design MicroJet Cryo-Trap

< MJT-1035E >

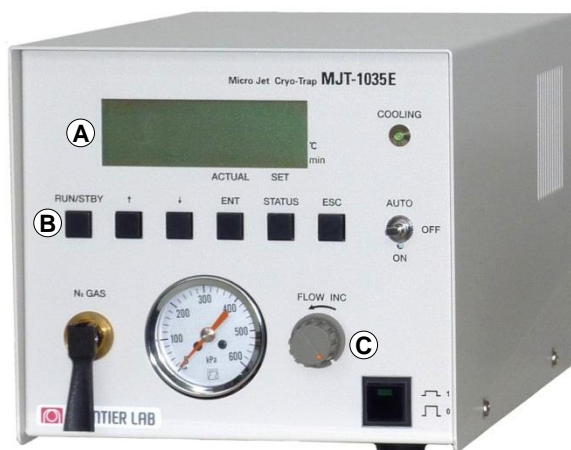
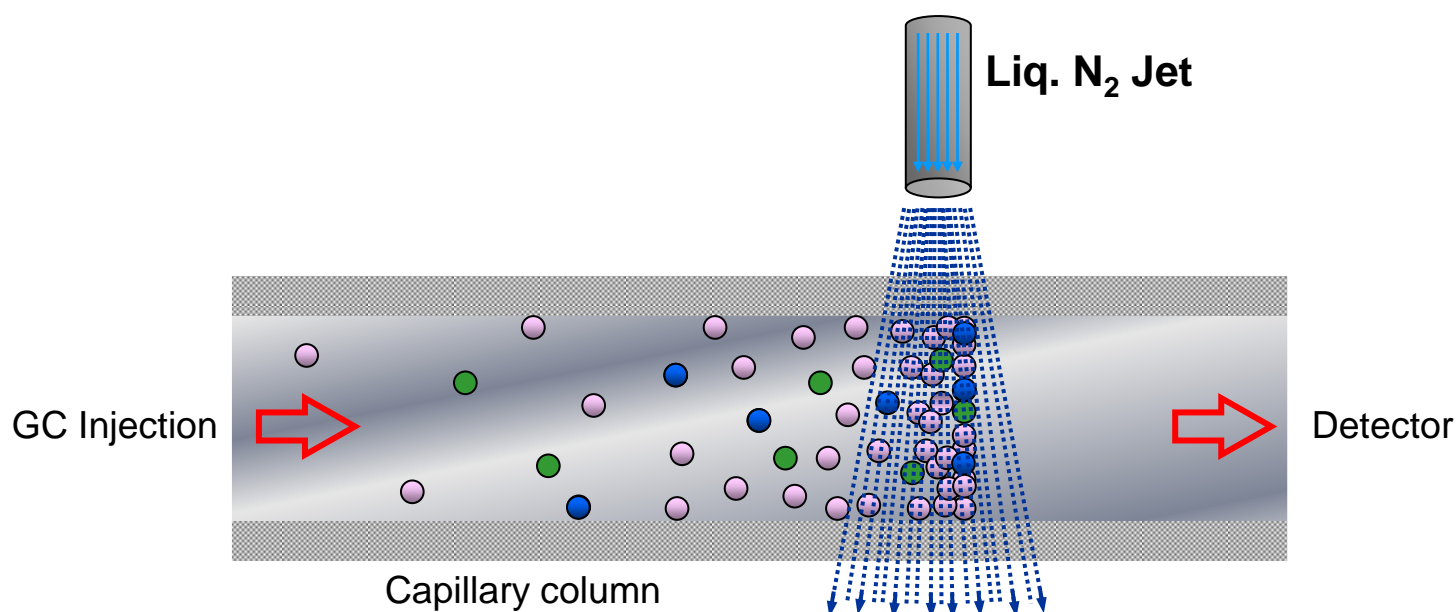

- Ⓐ LCD screen for temperature monitor and set up
- Ⓑ Buttons for set up – mainly for standalone use
- Ⓒ Flow control to vary cryo-trap temperatures

**MJT-1035E Controller**

# Background of development

Chromatography is dramatically improved using cryogenic trapping of gases and volatiles compounds at the head of an analytical separation column. Cryo-trapping is used with sample introduction devices that slowly introduce volatile compounds to a GC or GC/MS. These devices include thermal desorption systems, headspace samplers, and purge & trap units. Frontier Laboratories introduced the first MicroJet Cryo-Trap over ten years ago. This system was designed exclusively for use with Frontier Lab's Pyrolyzers. With the introduction of the new universal MicroJet Cryo-Trap (MJT-1035Ex) and controller, customers can now use this proven cryo-trapping technology with either Frontier Lab's Pyrolyzers or other sample introduction devices, such as headspace and purge & trap systems, from other vendors.

## Features

### Energy efficient rapid cooling and instant thermal desorption

Stable cooling cryo-trapping temperature of  $-196^{\circ}\text{C}$  can be achieved within 2 minutes from the start of liquid nitrogen jet. Once the nitrogen jet is terminated, the cryo-trapping section of the column is heated at a rate of  $800^{\circ}\text{C}/\text{min}$  by the heated air from the GC oven for rapid thermal desorption. Compared with similar products from other companies, the total liquid nitrogen consumption is  $1/3$  less, making the MicroJet Cryo-Trap significantly more economical and ecologically efficient.

Because the MicroJet Cryo-Trap (MJT-1035E) traps analytes on a very narrow band at the head of the analytical column, excellent chromatography and peak resolution can be achieved upon rapid thermal desorption.

### Variable cooling temperatures

As shown in Fig. 1, by varying the nitrogen gas flow rate, the desired cooling temperatures can be obtained.

### Universal design

This MicroJet Cryo-Trap can collaboratively work with many types of sample introduction devices such as purge & trap, headspace sampler, pyrolyzer, etc. via remote start.

## Operational principle (US Patent US6,190,613B1)

Nitrogen gas is liquefied by passing through the thermal exchange coil immersed in liquid nitrogen at a rate of  $3\text{--}7\text{ L}/\text{min}$ . The liquefied nitrogen is directed against a very narrow section at the head of an analytical separation column situated in the MicroJet tube. This cools the section of the column, which cryo-traps the target compounds.

Rapid thermal desorption is achieved by closing the solenoid valve, allowing the heated air circulating in the GC oven to heat the cooled section of the column at a rate of up to  $800^{\circ}\text{C}/\text{min}$ . This rapid desorption of the trapped analytes on the column is very reproducible and provides excellent peak separation.

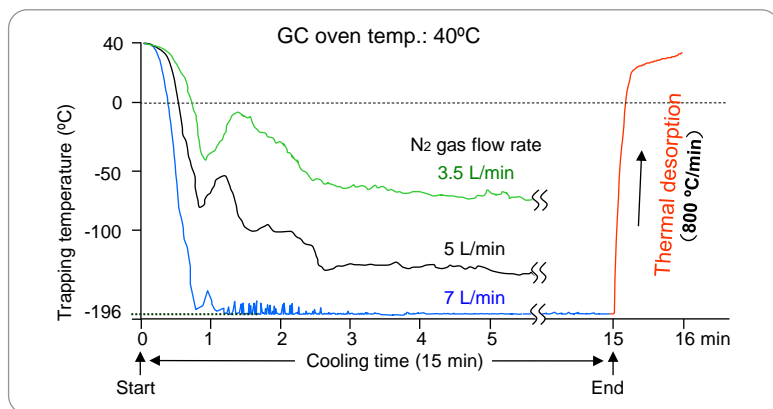

Fig. 1. Cooling rate, temperature stability and thermal desorption

### Trapping volatile gases ( $\text{CO}_2$ , ethane, etc.)

While a liquefied nitrogen jet is directed against the column,  $5\text{ }\mu\text{L}$  of light gases are injected and cryo-trapped for 5 minutes at the head of a separation column. The nitrogen jet is then terminated allowing the heated air in the GC oven to desorb the trapped gases. The chromatogram obtained is shown in Fig. 2, showing separation of these gases with good resolution.

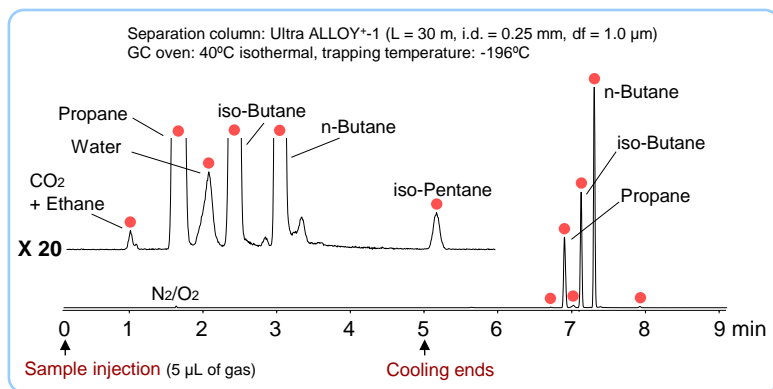

Fig. 2. Trapping performance of light gases

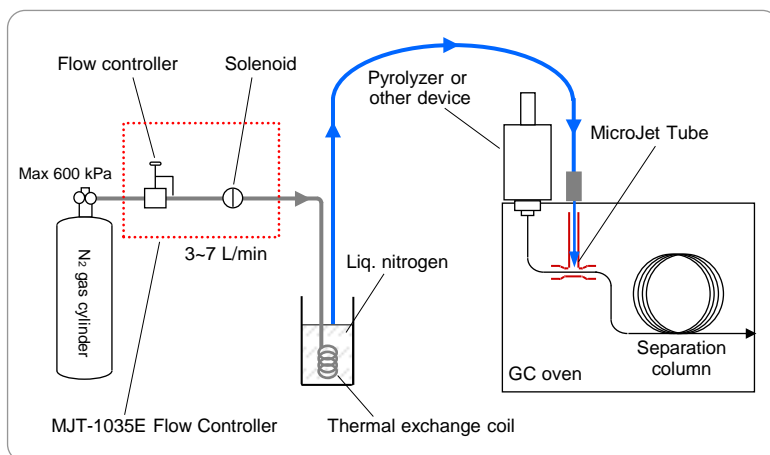

Fig. 3. Flow scheme of MJT-1035E

## Cryo-trapping at the head of separation column and thermal desorption

### Anti-icing feature prevents ice build-up from moisture in the air

Nitrogen gas is swept through the inside of the MicroJet tube and mixed by integrated baffles, which helps prevent ice build-up on the column. Ice build-up on the separation column may result in split peaks and bleeding in the chromatogram. This anti-icing feature allows consistent rapid thermal desorption of the analytes for improved peak separation.

### New nitrogen saver mode reduces consumption and allows trap temperature to be controlled.

Consumption of nitrogen gas and Liquid N<sub>2</sub> are reduced by 30% compared to the previous model (MJT-1030E), and many competitive offerings. In addition, by adjusting the nitrogen flow rate, the cooling temperature at the head of the separation column can be varied as shown in the table below.

#### Nitrogen consumption and trapping performance

Approx. cooling temp. (°C)	-190	-150	-50
N <sub>2</sub> gas flow rate (L/min)	7	5*	3.5
Liq. N <sub>2</sub> consumption (mL/min)	20	15*	10
Compounds to be trapped**	>C2	>C4	>C9

\* 1/3 or less than that of competitors. \*\*1 μm film capillary column used.

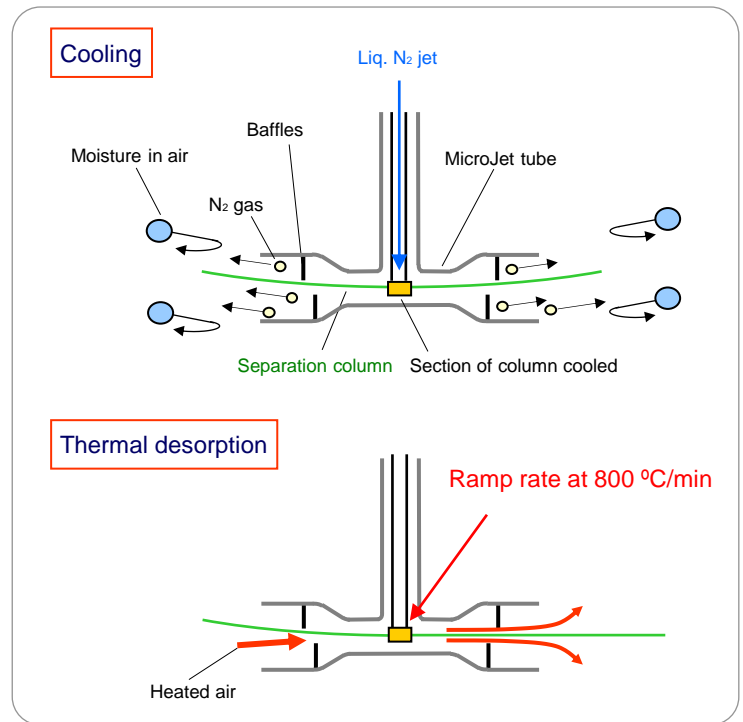

Fig. 4. Gas flow scheme inside MicroJet Tube

## Analytical examples using the MicroJet Cryo-trap

### Headspace analysis of a red wine

A headspace analysis of a red wine using MicroJet Cryo-Trap is shown in Fig. 5. One mL of headspace gas was sampled from a red wine bottle, and directly injected into a GC injection port. Volatiles concentrated by cryo-trapping at the head of a column were analyzed by GC/MS. Typical compounds found in wine were observed on the chromatogram.

#### Analytical conditions:

Trapping temperature: -196°C,  
Column.: Ultra ALLOY+1 (L=30 m, i.d.=0.25 mm, df=1.0 μm)  
GC oven: 40 - 280°C (20 °C/min, 5 min hold),  
Carrier gas: He, 1 mL/min, split ratio: 1/50

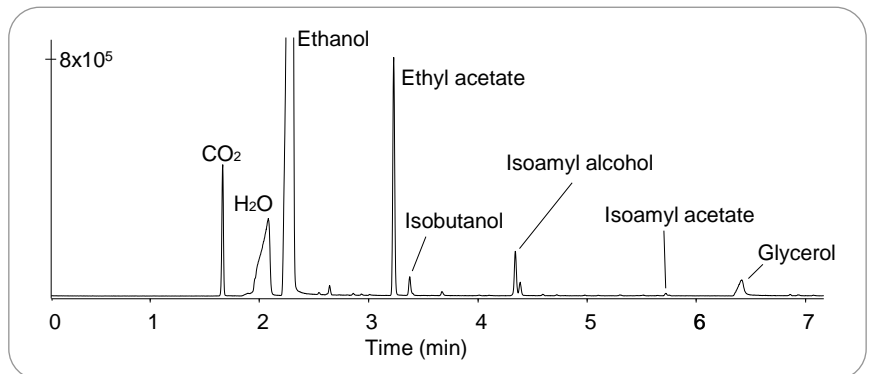

Fig. 5. Head space analysis of a red wine

### Heart-cut analysis of a ceramic composite using a Multi-Shot Pyrolyzer (EGA/PY-3030D)

An example of automated analysis of thermal zones (A, B, C, D) in an EGA thermogram of a ceramic composite is shown in Fig. 6.

The MicroJet Cryo-Trap is used to trap volatile analytes found in zone A. A heart-cutting EGA mode, exclusive to Frontier Lab's Multi-Functional Pyrolyzer, uses a Selective Sampler\* to introduce only the components in each thermal zone to the GC column. This results in individual chromatograms for each zone.

Using mass spectral libraries it was found that zone A contained di-n-butyl phthalate, a plasticizer; zone B contained waxes; and zones C and D contained pyrolyzates of polybutylmethacrylate and polystyrene, respectively.

The entire process of heart-cutting EGA zones A-D, cryo-trapping the analytes, and obtaining the individual chromatograms can be automated using the Frontier Lab EGA/PY-3030D Multi-Shot Pyrolyzer and Auto-shot Sampler.

\* An accessory available from Frontier Laboratories

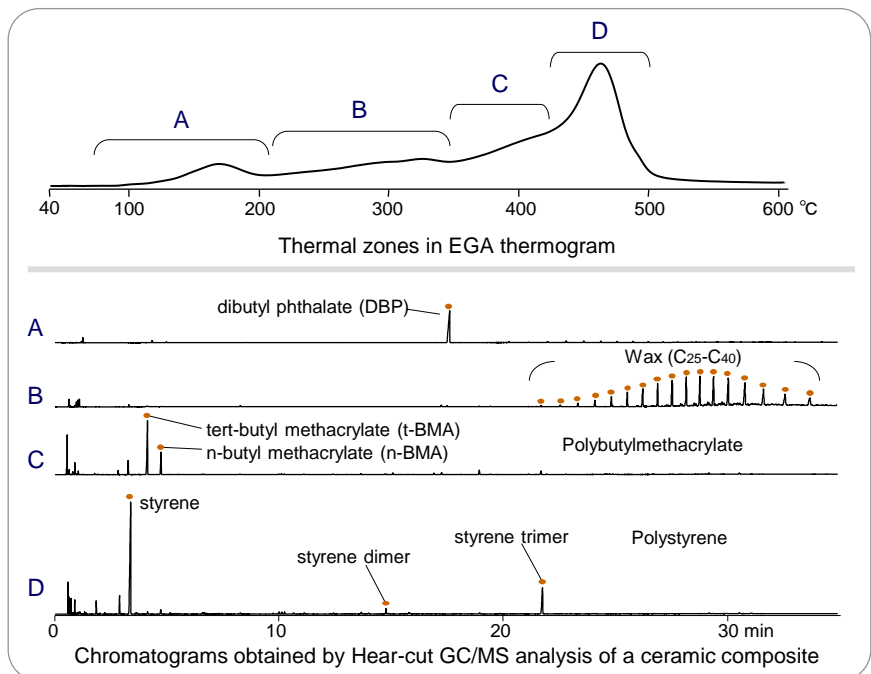
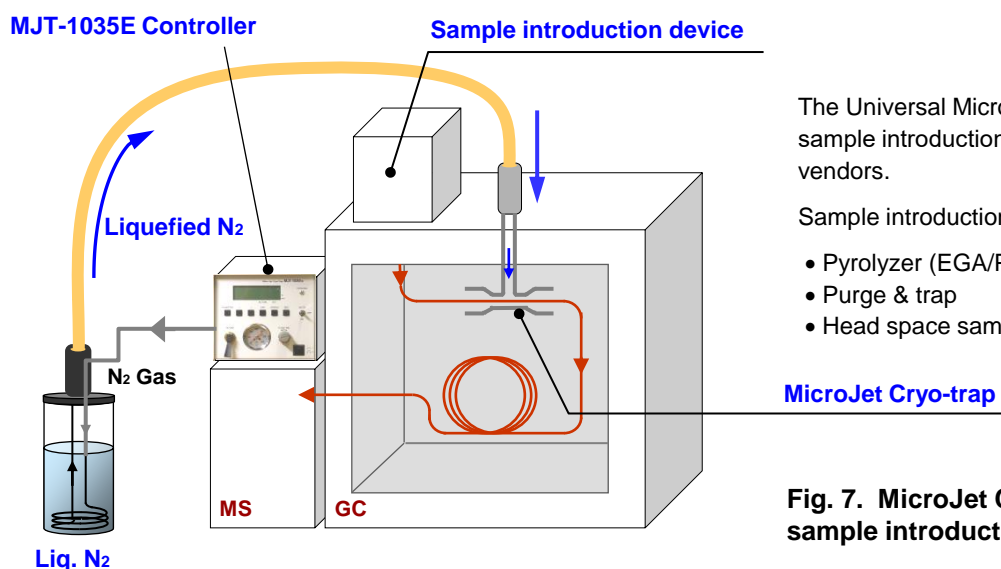

Fig. 6. EGA thermogram and Heart-cut GC/MS analysis

# Cryo-trapping from a variety of sample introduction devices



The Universal MicroJet Cryo-Trap works with a variety of sample introduction devices and GC's from multiple vendors.

Sample introduction devices include:

- Pyrolyzer (EGA/PY-3030D)
- Purge & trap
- Head space sampler

**MicroJet Cryo-trap**

**Fig. 7. MicroJet Cryo-Trap coupled with a sample introduction device on a GC/MS system**

## Specifications

MicroJet Cryo-Trap (MJT-1035E)	SPECIFICATIONS	DESCRIPTION
◆ Lowest cooling temp.	Approx. -196°C (N <sub>2</sub> : 7 L/min; GC oven temp.: 40°C)	Traps volatile gases such as ethane, propane, butanes, and others including CO <sub>2</sub> .
◆ Separation column	Metal capillary column (id. 0.25 mm or smaller); fused silica (FS) capillary column <sup>1)</sup> (id. 0.53 mm or smaller)	Choose the separation column that meets your needs.
◆ Cooling rate	Approx. -196°C in 2 min (N <sub>2</sub> : 7 L/min, GC oven temp.: 40°C)	Fast cooling that is both efficient and ecological. High through-put, and saves N <sub>2</sub> and liquid N <sub>2</sub> .
◆ Thermal desorption	Via heated circulating air in GC oven.	No heater used. Instant desorption with a ramp rate of 800 °C/min (GC oven temp. at 40°C). Anti-icing feature prevents ice buildup on column. Reproducible chromatograms with excellent resolution.
◆ Temperature control	Cryo-trap temperatures controllable by varying N <sub>2</sub> flow rate.	Approximate temp.: -196°C (7 L/min), -150°C (5 L/min), -50°C (3.5 L/min). Allows user to select flow rate and saves N <sub>2</sub> & liquid N <sub>2</sub> .
◆ LCD display	4-line LCD display with control buttons.	Buttons allow set point control. LCD provides readout. Actual temperature monitor with thermocouple reading.
◆ Compatibility <sup>2)</sup>	Compatible with GC's from Agilent, Perkin Elmer, Shimadzu, Thermo Fisher, and others. Compatible with most sample introduction devices with remote start/stop capability.	Universal design. Works with many GC's and sample introduction devices such as headspace, purge & trap, gas sampling valve. Allows standalone use. Complete automation with Frontier Lab's Pyrolyzer, Auto-Shot Sampler, and Selective Sampler.
◆ Unit and accessory	Flow controller, MicroJet unit, liquid nitrogen container (2 L), and generic remote/start cable (no specific connector on one end)	
◆ Power	100~240 VAC, 25 W	
◆ Requirements	<ul style="list-style-type: none"> <li>• Liquid N<sub>2</sub> (minimum 2 L; liquid N<sub>2</sub> consumption when cooling at -150°C: approx. 15 mL/min)</li> <li>• N<sub>2</sub> cylinder (secondary pressure up to 600 kPa (87 psi); N<sub>2</sub> consumption: approx. 5 L/min)</li> </ul>	
◆ Options	Thermal exchange coil and lid for Chart MVE Lab 30 Dewar (30 L) <sup>3)</sup>	

1) FS column may break, if it is rapidly cooled.

2) May not be installable, if another device is on the top of your GC oven.

3) Customer can purchase a 30 L Dewar from a local supplier.

Note: For automated analysis, GC and sample introduction device (e.g. auto sampler) must be able to communicate via this device (MJT-1035E). If not, automated analysis cannot be performed.